

USERS GUIDE

SW-M818



E-Bike Display
Model: SW-M818
Protocol: Lithium II
Version: V6.05



Scan QR Code
to Download PDF

Changzhou Sciwil E-Mobility Technology Co., Ltd.



Wechat



Website

Contents

I . Safety Notes	3
II . Overview	4
1. Product Name and Model	4
2. Product Introduction.....	4
3. Specifications.....	4
4. Function.....	4
5. Size.....	5
6. Assembly.....	5
7. Serial Code.....	6
III. Operation	7
1. Display Interface	7
1.1 Riding Interface.....	7
1.2 Setting Interface.....	8
1.3 Error Interface.....	8
2. Key Pad	9
3. Key Operation	9
3.1 On/Off.....	9
3.2 Assist Level.....	10
3.3 Toggle Displays.....	10
3.4 Light On/Off.....	10
3.5 Walk Assist Mode.....	10
4. Settings	10
5. Error Code	13
6. Connection	13
IV. Warranty	14
V. Version	14

I . Safety Notes

PLEASE TAKE CAUTION WHEN USE, DO NOT PLUG OR UNPLUG THE DISPLAY WHILE YOUR E-BIKE IS POWERED ON.

- AVOID CLASHES OR BUMPS TO THE DISPLAY.

- AVOID USING IN HEAVY RAINS, SNOWS OR LONG EXPOSURE TO STRONG SUNLIGHT. DO NOT TEAR THE WATER-PROOF FILM ON THE SURFACE OF THE SCREEN, OTHERWISE THE WATER-TIGHT PERFORMANCE OF THE PRODUCT MAY BE DEGRADED.

- DO NOT PLUG OR UNPLUG THE DISPLAY WHILE THE SYSTEM IS POWERED ON. UNAUTHORIZED ADJUSTMENT TO DEFAULT SETTINGS IS NOT SUGGESTED, OTHERWISE NORMAL USE OF YOUR E-BIKE CAN NOT BE GUARANTEED.

- WHEN THE DISPLAY PRODUCT DOES NOT WORK PROPERLY, PLEASE SEND THE IT FOR AUTHORIZED REPAIR IN TIME.

II. Overview

1. Product Name and Model

Product Name: E-Bike Display

Product Model: SW-M818

2. Product Introduction

SW-M818 features high-brightness anti-glare color LCD and minimalist interface, working as an ideal HMI solution for EN15194 electric bikes.

3. Specifications

- Working Voltage: DC 24V/36V/48V/60V/72V
- Rated Working Current: 12mA
- Leakage current: <1uA
- Screen Size: 4.0"LCD
- Communication Type: UART (by default) / CAN (optional)
- Optional Functions: Bluetooth, NFC
- Working Temperature: -20°C ~ 60°C
- Storage Temperature: -30°C ~ 70°C
- Waterproof Rating: IP66

4. Function

- Boot password
- System unit switch (km/h or mph)
- Assist Level Control and Display
- Battery indication: battery level percentage, low voltage indication
- Speed display: (in km/h or mph)
real-time speed (SPEED), max speed (MAX), average speed (AVG)
- Distance: single-trip distance (TRIP), total travel distance (ODO)
- Assist Mode Control and Display (3/5/9 levels)
- Walk assist mode

- Front light indication: front light status supported by controller.
- Error code indication
- Riding Info: Braking Status, Front Light Status, Cruise, Low Voltage.
- Turning Signals: This function works with controller.
- Dual Drive Control and Display: This function works with controller.
- Status of Double Battery Packs: optional, works with controller.
- NFC Function: optional.
- Bluetooth Connection: optional, support OTA upgrade via mobile phone.

5. Size

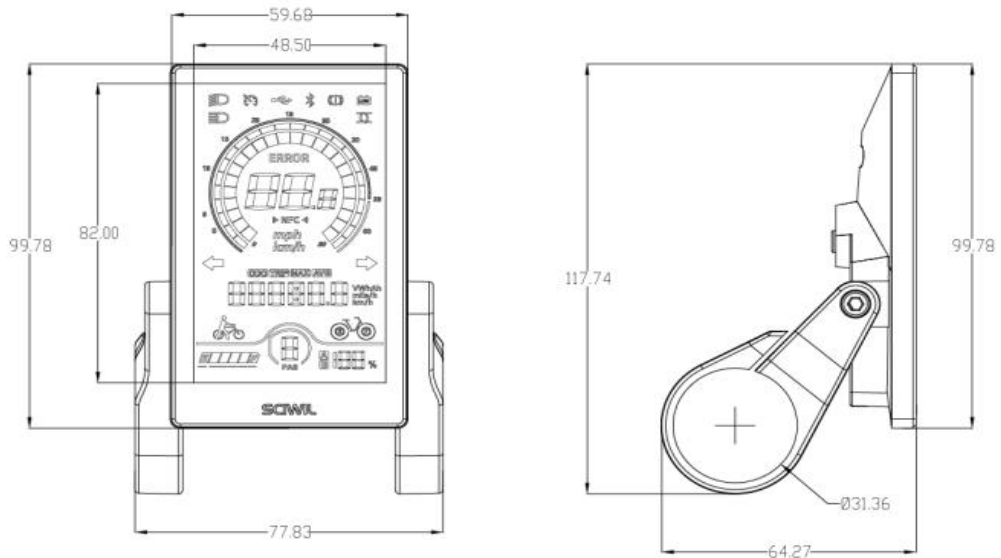

6. Assembly

① Open the holder ring/rubber spacer of the display and fix the display on the handlebar, adjust it to a proper facing angle. Use a M4 Hex Wrench to fix and tighten the screws. Standard fixing torque: **1N·m**.

***Damage due to excessive fixing torque is not covered by warranty.**

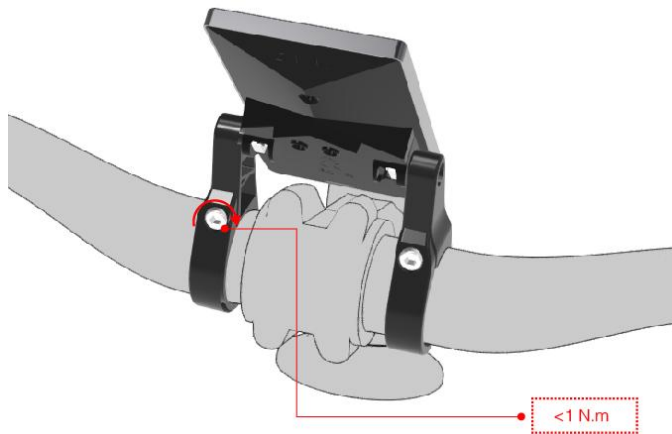

② Open the holder ring/rubber spacer of the keypad and fix it on the handlebar, adjust it to a proper facing angle. Use a M3 Hex Wrench to fix and tighten the screws. Standard fixing torque: **1N·m**.

***Damage due to excessive fixing torque is not covered by warranty.**

③ Plug the 5-pin connector of the display to the coupling connector of the Controller.

7. Serial Code

Example:

111 22 333333 555 6666

36V

← Marked at the back of display

111: Customer Code

22: Protocol Code

333333: P.O. Date (YYMMDD)

555: Order Receiving Number

6666: Production Date (YYMM)

III. Operation

1. Display Interface

1.1 Riding Interface

- Status: Real-time Riding Status: Bluetooth, Front Light, Brake, Low Voltage, Turning, Cruise, Drive Status, etc.
- Battery Status: Residual Battery Percentage
- Multi-Function Section: ODO (total range), TRIP (single ride range), MAX (max. speed), AVG (average speed), TIME (riding time), VOL (battery voltage), Wh (motor power), CUR (current), etc.
- Assist Level Mode: 3/5/9 Levels available.

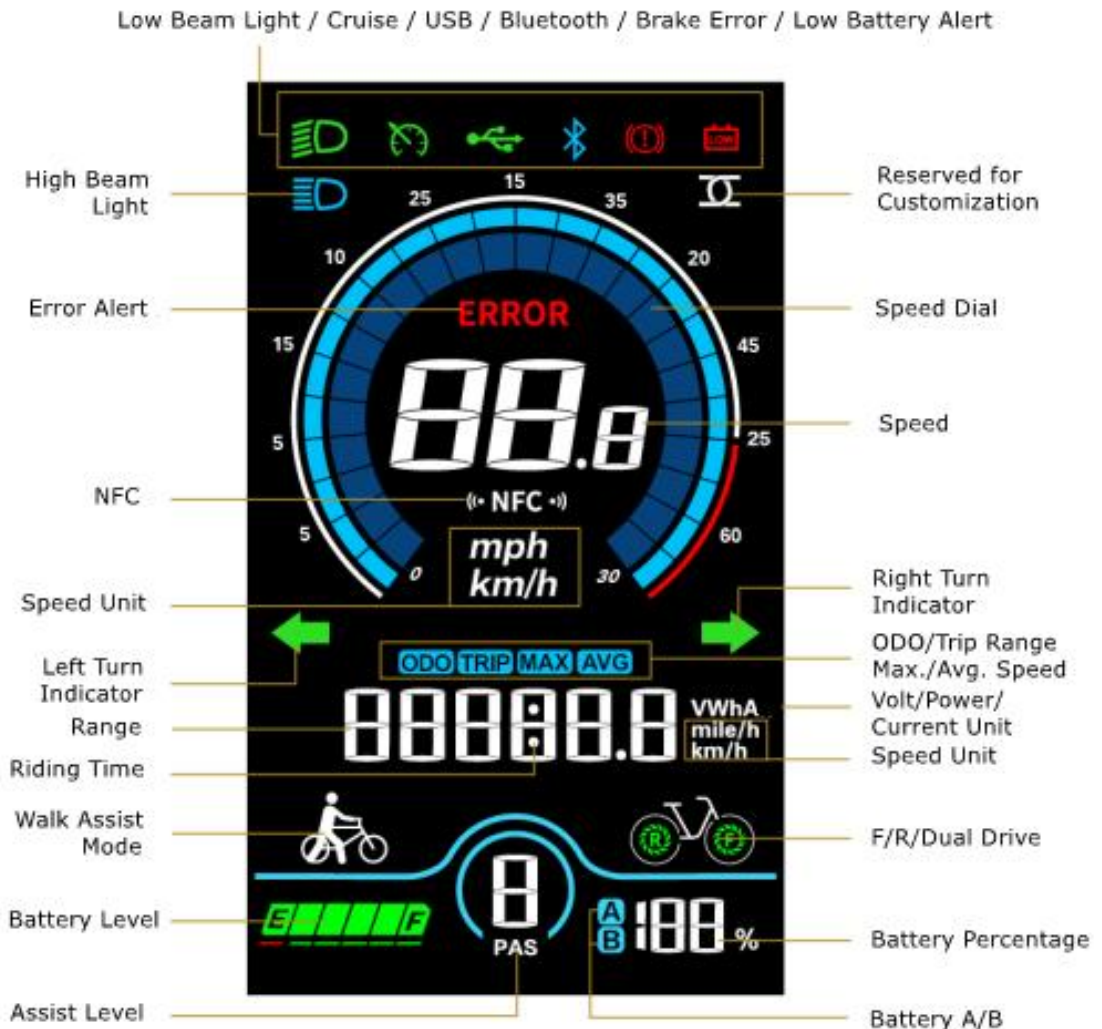

1.2 Setting Interface

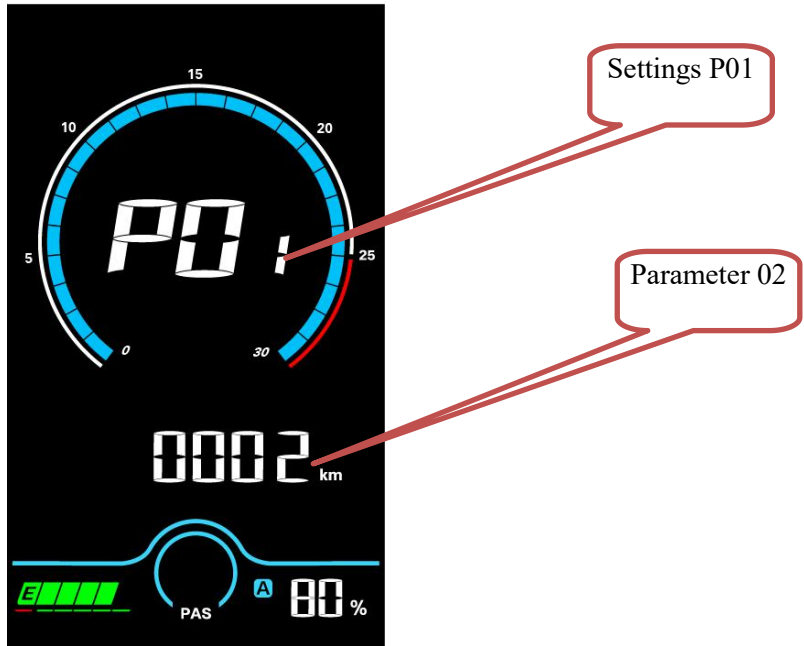

In the above interface: Setting Item: P01, Parameter Value: 02

1.3 Error Interface

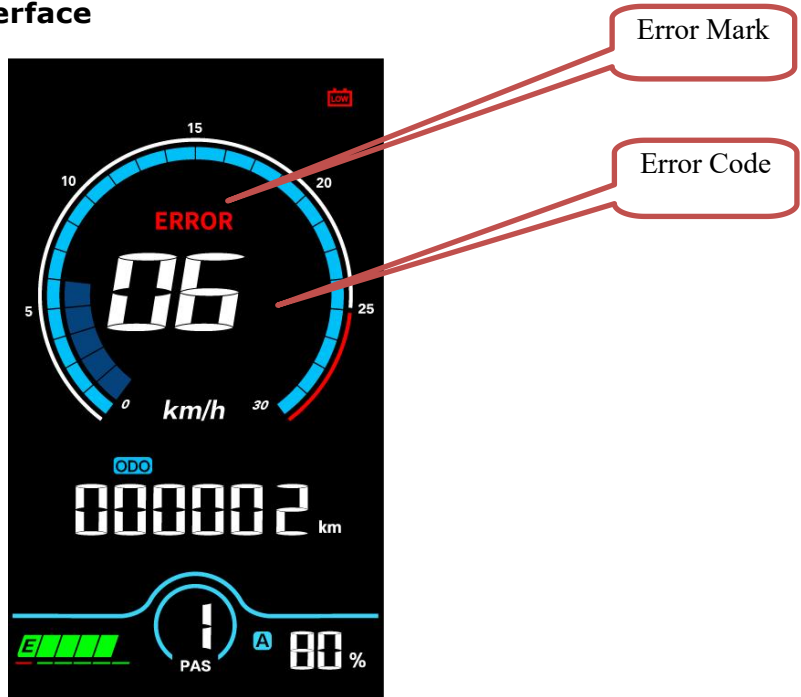

In the above interface: Error Indicator: ERROR, Error Code: 06

2. Key Pad

SWK2 Keypad Illustration:



There are 5 keys on the SWK2 keypad, in the following instructions:

+ is called Plus Key;

⏻ is called On/Off Key;

- is called Minus/Walk Assist Key;

💡 is called Light Key;

i is called Info Key;

3. Key Operation

Key operation guide as follows:

Press and Hold: means press and hold the key(s) for more than 2s.

Press: means press the key(s) for less than 0.5s.

Double Tap: means double tap the key(s) within 0.3s

3.1 On/Off

Turn on the Display: When the display is off, press and hold the On/Off Key to turn on the display, it will show boot interface and then enter riding interface. (If boot password is activated, enter the boot password at start).

Turn off the Display: When the display is on, press and hold the On/Off Key, the display will be turned off. If no operation is engaged for 10min

(0km/h), the display will be auto-off. Auto-off time can be set in the Settings.

3.2 Assist Level

Press the Plus Key or Minus/Walk Assist Key to switch assist levels. There are 5 levels by default: 0/1/2/3/4/5. 0 means no assist power.

3.3 Toggle Displays

When the display is on, press the Info Key to toggle among ODO (total range), Trip (single trip range), TIME (riding time) etc.

3.4 Light On/Off

Turn on the Front Light: when the front light is off, press the Light Key to turn it on, and the light icon will be shown on the riding interface (to remove this functions, please reconfigure the controller).

Turn off the Front Light: when the front light is on, press the Light Key to turn it off, and the light icon will be off on the riding interface.

3.5 Walk Assist Mode

Engage Walk Assist Mode: On the riding interface, press and hold the Minus/Walk Assist Key to enter walk assist mode. Hold the Minus/Walk Assist Key to engage walk assist mode, the walk mode icon will be shown on the riding interface, the real-time speed will be shown in the speed section.

Disengage Walk Assist Mode: release the Minus/Walk Assist Key to disengage the walk assist mode, the icon will off on the riding interface.

4. Settings

4.1 Setting Operations

① **Enter the Settings:** when the display is on, press and hold the Plus Key and the Minus/Walk Assist Key together to enter the Settings. Available setting items include: system voltage, wheel size (inch), magnetic steel number for speed gauge, speed limit etc (please refer to 4.2 Setting Items).

② **Adjust Settings:** on the Settings interface, press the Plus Key or the Minus/Walk Assist Key to set values for items. The value will blink after change. Press the On/Off Key to save the set value and switch to next item.

③ **Save and Exit Settings:** press and hold again the Plus Key and the Minus/Walk Assist Key together to exit the Settings and save the set value. The system will save and exit automatically if there's no operation for 10s.

4.2 Setting Items

■ **P00: Factory Reset:** optional.

■ **P01: Backlight Brightness.** 1: darkest; 3: brightest.

■ **P02: System Unit.** 0: km (metric); 1: mile (imperial).

■ **P03: System Voltage:** 24V/36V/48V/60V/72V.

■ **P04: Auto-Off Time**

0: never, other value means auto-off time interval. Unit: minute

■ **P05: Pedal Assist Level**

● 0-3 Level Mode; 1-3 Level Mode (no Level0)

● 0-5 Level Mode; 1-5 Level Mode (no Level0)

● 0-9 Level Mode; 1-9 Level Mode (no Level0)

■ **P06: Wheel Size.** Unit: inch; Increment: 0.1.

■ **P07: Motor Magnets Number for Speed Gauge.** Range: 1-100

P08: Speed Limit. Range: 0-100km/, communications status (controller-controlled). The max speed will be kept constant at the set value.

Error Value: ± 1 km/h (applicable to both the PAS/throttle mode)

Note: The above-mentioned values are measured by metric unit (km/h). When the system unit is set to imperial unit (mph), the speed displayed will be automatically switched to corresponding value in imperial unit, however the speed limit value in the imperial unit interface won't change accordingly.

■ **P09: Direct Start / Kick-to-Start**

- 0: Direct Start (Throttle-on-demand);
- 1: Kick-to-Start

■ **P10: Drive Mode Setting**

- 0: Pedal Assist – The pedal assist level decides the motor power output. In this status the throttle does not work.
- 1: Electric Drive – The e-bike is only controlled by the throttle. In this status the pedal assist does not work.
- 2: Pedal Assist + Electric Drive (electric drive does not work in direct-start status)

■ **P11: Pedal Assist Sensitivity.** Range: 1-24.

■ **P12: Pedal Assist Starting Intensity.** Range: 0-5.

■ **P13: Magnets Number in Pedal Assist Sensor.** 3 Types: 5/8/12pcs.

■ **P14: Current Limit Value.** By default: 12A. Range: 1-20A.

■ **P15: Display Low Voltage Value.**

■ **P16: ODO Clearance.** Press and hold the Plus key for 5s and ODO value will be cleared.

■ **P17: Cruise.** 0: cruise function deactivated, 1: cruise function activated.

■ **P18: Throttle Level Control.** 0: throttle speed isn't divided into different levels, 1: throttle speed is leveled as pedal assist levels.

■ **P19: Auto-Light.** 0: auto-light deactivated, 1: auto-light activated.

■ **P20: Sensitivity of Light Sensor.** Range: 20-100

■ **P21: Boot Password.** 4-Digit.

■ **P22: Password for Advanced Settings.** 4-Digit.

5. Error Code

Error Code (decimal)	Status	Note
E00	Normal	
E01	Reserved	
E02	Brake Error	
E03	PAS Sensor Error (Riding Mark)	Not Realized
E04	Walk Assist Mode	
E05	Real-Time Cruise	
E06	Low Voltage Protection	
E07	Motor Error	
E08	Throttle Error	
E09	Controller Error	
E10	Communications Error	
E12	BMS Communications Error	
E13	Front Light Error	

6. Connection

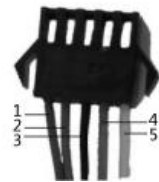
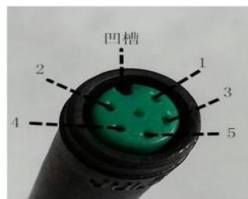
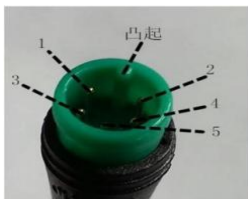

Display to Controller

Controller to Display

Controller Connector

Pin No.	Wire Color	Functions
1	Red (VCC)	Display Power Wire
2	Blue (K)	Electric Lock Wire
3	Black (GND)	Display Ground Wire
4	Green (RX)	Display Data Receiving Wire
5	Yellow (TX)	Display Data Sending Wire

Extended Functions- Front Light:

Brown (DD): The power wire (+) of the light

White (GND): The ground wire (\cong) of the light.

Note: For waterproof connectors, wire sequences are concealed.

IV. Warranty

In compliance with local laws, Sciwil provides limited warranty period covering **24 months** after the date of manufacturing (as indicated by the serial number), applies to quality issues during normal operations.

The limited warranty shall not be transferred to a third party other than as specified in the agreement with Sciwil.

Warranty Exclusions:

- 1. Sciwil products that have been opened, modified or repaired without authorization.
- 2. Damage on the connectors.
- 3. Damage to the surface after leaving factory, including shell, screen, buttons, or other appearance parts.
- 4. Damage to wiring and cables after leaving factory, including breaks and exterior scratch.
- 5. Damage or loss due to force majeure (e.g. fire or earthquake) or natural disaster (e.g. lightning).
- 6. Out of the warranty period.

V. Version

This display user manual is in compliance with the general software version (A/0) of Changzhou Sciwil E-Mobility Technology Co., Ltd. There are chances that display products on some e-bikes may have a different software version, which is subject to the actual version in use.